



AC Motor Drives

EMC Standard Installation Guide EMC Compliance Practice

Preface

When an AC motor drive is installed in a noisy environment, radiated and/or conducted noise via signal and power cables can interfere with the correct functioning, cause errors or even damage to the drive. To prevent this, some AC motor drives have an enhanced noise resistance but the results are limited and it is not economical. Therefore, an effective method would be finding the cause of the noise and use the right solution to achieve “no emission, no transmission and no reception of noise”. All three solutions should be applied.

Finding the Noise

- Ascertain whether the error is caused by noise.
- Find the source of the noise and its transmission path.
- Confirm the signal and the source of noise

Solutions

- Grounding
- Shielding
- Filtering

Table of Contents

Preface	i
Table of Contents	ii
Chapter 1 Introduction.....	1
1.1 What is EMC	1
1.2 EMC for AC Motor Drive	1
Chapter 2 How to prevent EMI	2
2.1 Types of EMI: common-mode and differential mode noise	2
2.2 How does EMI transmit? (Noise transmission)	2
Chapter 3 Solution to EMI: Grounding	4
3.1 Protective Grounding & Functional Grounding.....	4
3.2 Ground Loops	5
3.3 Earthing Systems	5
Chapter 4 Solution to EMI: Shielding	9
4.1 What is Shielding?	9
4.2 How to Reduce EMI by Shielding?	10
Chapter 5 Solution to EMI: Filter	12
5.1 Filter	12
5.2 Harmonic Interference.....	14

Chapter 1 Introduction

1.1 What is EMC?

Electromagnetic Compatibility (EMC) is the ability of an electrical device to function properly in electromagnetic environments. It does not emit electromagnetic noise to surrounding equipment and is immune to interference from surrounding equipment. The goal is to achieve high immunity and low emission; these two properties define the quality of EMC. In general, electrical devices react to high and low frequency phenomena. High frequency phenomena are electrostatic discharge (ESD); pulse interference; radiated electromagnetic field; and conducted high frequency electrical surge. Low frequency phenomena refer to mains power harmonics and imbalance.

The standard emission and immunity levels for compliance depend on the installation location of the drive. A Power Drive System (PDS) is installed in an industrial or domestic environment. A PDS in a domestic environment must have lower emission levels and is allowed to have lower immunity levels. A PDS in an industrial environment is allowed to have higher emission levels but must have more severe immunity levels.

1.2 EMC for AC Motor Drive

When an AC motor drive is put into operation, harmonic signal will occur at the AC drive's power input and output side. It creates a certain level of electromagnetic interference to the surrounding electrical devices and the mains power network. An AC motor drive is usually applied in industrial environments with a strong electromagnetic interference. Under such conditions, an AC drive could disturb or be disturbed.

Delta's AC motor drives are designed for EMC and comply with EMC standard EN61800-3 2004. Installing the AC motor drive accurately will decrease EMI influences and ensure long term stability of the electricity system. It is strongly suggested to follow Delta's user manual for wiring and grounding. If any difficulties or problems arise, please follow the instructions and measures as indicated in this EMC Standard Installation Guide.

Chapter 2 How to prevent EMI

2.1 Types of EMI: Common-mode and differential-mode noise

The electromagnetic noise of an AC motor drive can be distinguished into common-mode and differential-mode noise. Differential-mode noise is caused by the stray capacitance between the conducting wires and common-mode noise is caused by the common-mode coupling current path created by the stray capacitance between the conducting wires and ground.

Basically, differential-mode noise has a greater impact to the AC motor drive and common-mode noise has a greater impact to high-sensitivity electronic devices. An excessive amount of differential-mode noise may trigger the circuit protection system of the AC motor drive. Common-mode noise affects peripheral electronic devices via the common ground connection.

EMC problems can be more serious when the following conditions apply:

- When a large horsepower AC motor drive is connected to a large horsepower motor.
- The AC motor drive's operation voltage increases.
- Fast switching of the IGBTs.
- When a long cable is used to connect the motor to the AC motor drive.

2.2 How does EMI transmit? (Noise transmission path)

Noise disturbs peripheral high-sensitivity electrical devices/systems via conduction and radiation, their transmission paths are shown hereafter:

1. Noise current in the unshielded power cable is conducted to ground via stray capacitances into a common-mode voltage. Whether or not other modules are capable to resist this common-mode noise depends on their Common-Mode Rejection Ratio (CMRR), as shown in the following figure.

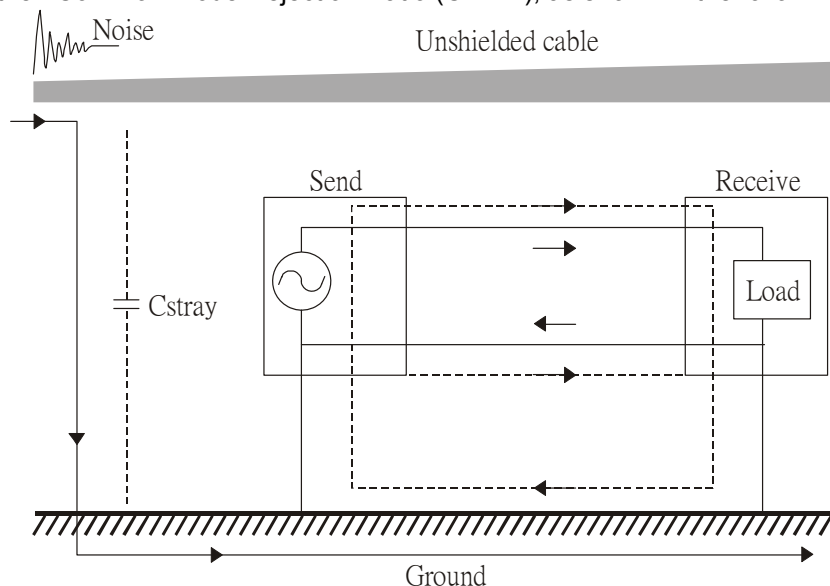

2. Common-mode noise in the power cable is transmitted through the stray capacitance and coupled into the adjacent signal cable, as shown in Figure 2. Several methods can be applied to reduce the effect of this common-mode noise; for example, shield the power cable and/or the signal cables, separate the power and signal cables, take the input and output side of the signal cable and twist them together to balance out the stray capacitance, let power cables and signal cables cross at 90°, etc.

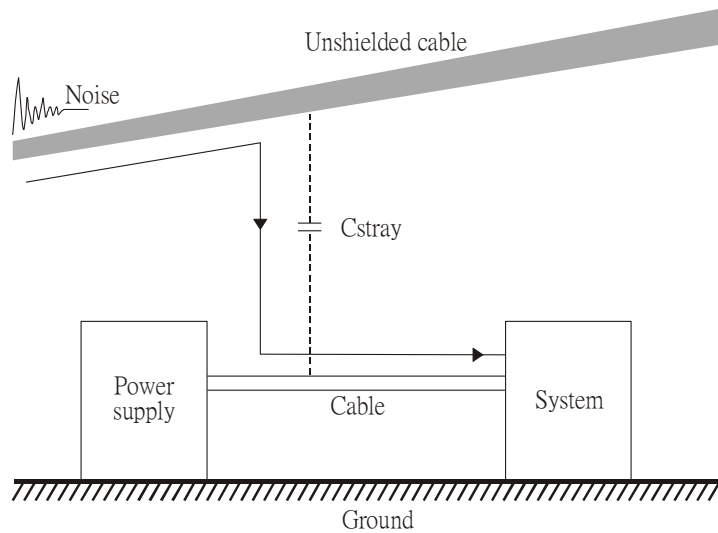

3. Common-mode noise is coupled via the power cable to other power systems then the cable of such a power system is coupled to the transmission system, as shown in Figure 3.

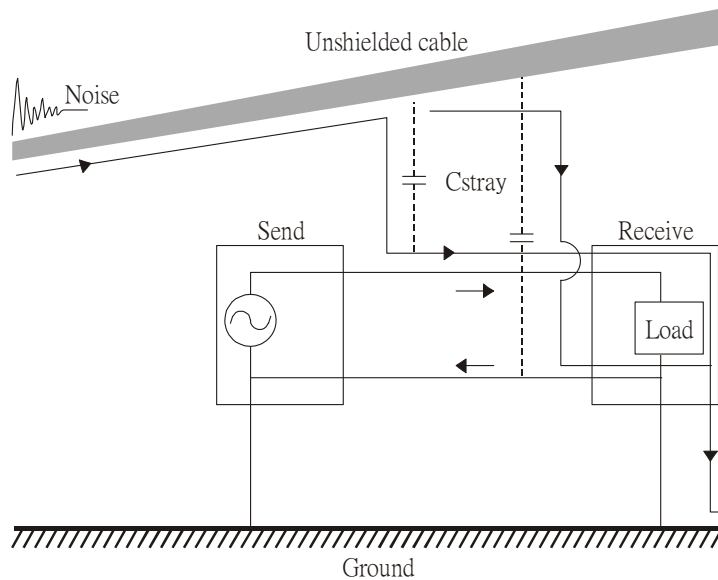

4. The common-mode noise of an unshielded power cable is transmitted to the ground via the stray capacitance. Since both shielded wire and unshielded wire are connected to a common ground, other systems can be interfered with by the common-mode noise that is transmitted from the ground back to the system via the shield. See Figure 4.

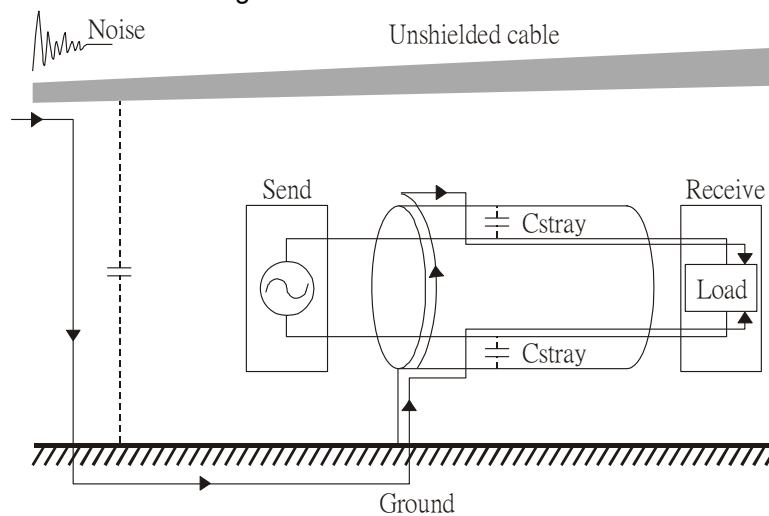

5. When excessive pulse modulated currents pass through an un-grounded AC drive cable, it acts as an antenna and creates radiated interference.

Chapter 3 Solution to EMI: Grounding

The leakage current of an electronic equipment is conducted to ground via the grounding wire and the ground electrode. According to Ohm's law, potential differences may arise when the electrode's ground and the ground's ground resistance are different.

According to Ohm's law, the earth resistance for electrode and the ground are different, in this case potential differences may arise.

3.1 Protective Grounding & Functional Grounding

Please carefully read the following instruction if two types of grounding are applied at the same time. Protective grounding is applied outside buildings and must have low resistance. On the other hand, functional grounding can be applied inside buildings and must have low impedance. The goal of EMC is to avoid any interference effects. Grounding for EMC can be distinguished by frequency. For frequencies lower than 10kHz, a *single-point ground* system should be used and for frequencies higher than 10 kHz, a *multiple point ground* system should be used.

- *Single Point Grounding*: all signal grounds of all IT equipment are connected in series to form a single reference point. This point can be grounded directly to earth; to the designated grounding point or to the safety point that is already grounded.
- *Multiple Point Grounding*: all signals of all IT equipment are grounded independently.
- *Hybrid Grounding*: this type of grounding behaves differently for low and high frequencies. When two pieces of IT equipment (A and B) are connected via a shielded cable, one end is connected directly to ground while the other end is connected to ground via a capacitor. This type of grounding system fulfils the criteria for high and low frequency grounding.
- *Floating grounding*: the signals of all IT equipment are isolated from each other and are not grounded.

DC current flows evenly throughout the conductor section. But AC current flows towards the conductor's surface as frequency increases; this is called the "skin effect". It causes the effective cross-section area to be reduced with increasing frequency. Therefore it is suggested to increase the effective ground cross-section area for high frequencies by replacing pigtail grounding by braided conductors or strip conductors. Refer to the following figure.

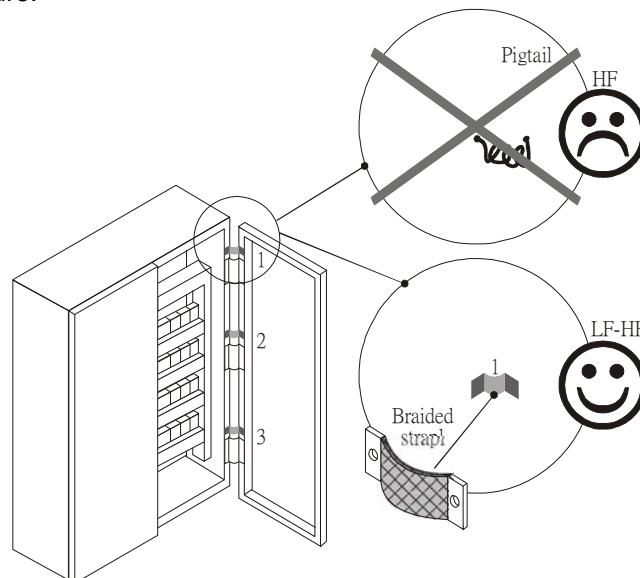

This is why a thick short ground wire must be implemented for connecting to the common grounding path or the ground busbar. Especially when a controller (e.g. PLC) is connected to an AC motor drive, it must be grounded by a short and thick conducting wire. It is suggested to use a flat braided conductor (ex: metal mesh) with a lower impedance at high frequencies.

If the grounding wire is too long, its inductance may interfere structure of the building or the control cabinet and form mutual inductance and stray capacitance. As shown in the following figure, a long grounding wire could become a vertical antenna and turn into a source of noise.

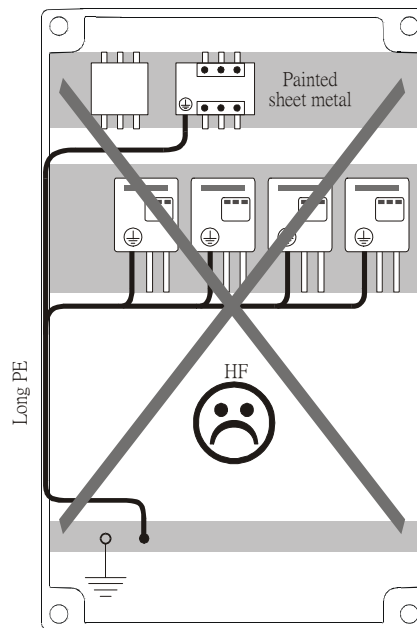

3.2 Ground Loops

A *ground loop* occurs when the pieces of equipment are connected to more than one grounding path. In this case, the ground current may return to the grounding electrode via more than one path. There are three methods to prevent ground loops

1. Use a common power circuit
2. Single point grounding
3. Isolate signals, e.g. by photocouplers

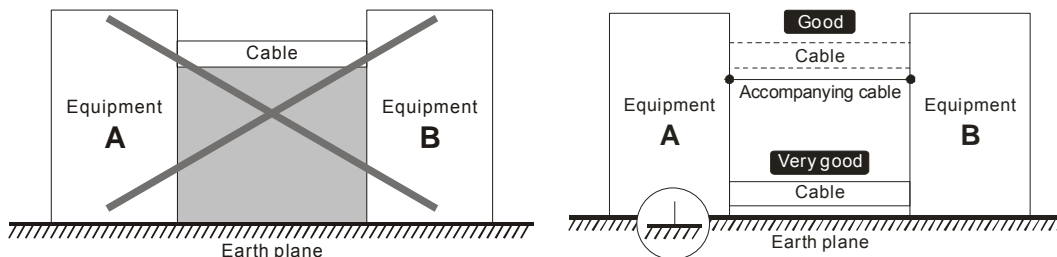

In order to avoid “Common Mode Noise”, please use parallel wires or twisted pair wiring. Follow this rule and also avoid long wires, it is suggested to place the two wires as close to each other as possible.

3.3 Earthing Systems

The international standard IEC60364 distinguishes three different earthing system categories, using the two-letter codes TN, TT, IT.

- The **first letter** indicates the type of earthing for the power supply equipment (generator or transformer).
 - T**: One or more points of the power supply equipment are connected directly to the same earthing point.
 - I**: Either no point is connected to earth (isolated) or it is connected to earth via a high impedance.
- The **second letter** indicates the connection between earth and the power supply equipment.
 - T**: Connected directly to earth (This earthing point is separate from other earthing points in the power supply system.)
 - N**: Connected to earth via the conductor that is provided by the power supply system
- The **third and fourth letter** indicate the location of the earth conductor.
 - S**: Neutral and earth conductors are separate
 - C**: Neutral and earth are combined into a single conductor

TN system

TN: The neutral point of the low voltage transformer or generator is earthed, usually the star point in a three-phase system. The body of the electrical device is connected to earth via this earth connection at the transformer.

protective earth (PE): The conductor that connects the exposed metallic parts of the consumer.

neutral (N): The conductor that connects to the start point in a 3-phase system or that carries the return current in a single phase system.

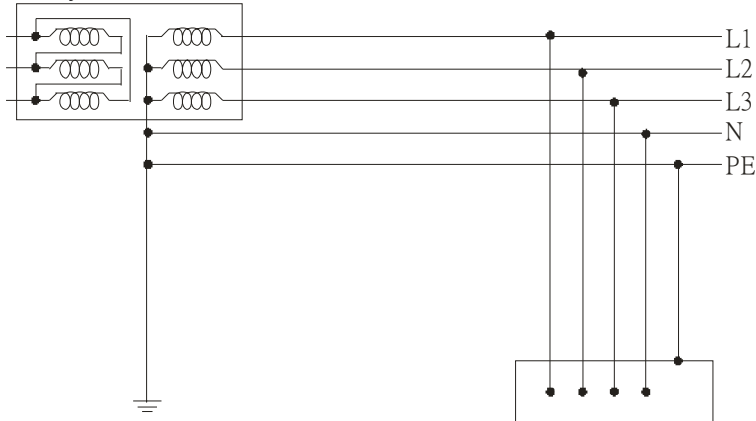

TN-S system

TN-S: PE and N are two separate conductors that are combined together only near the power source (transformer or generator). It is the same as a three-phase 5-wire system.

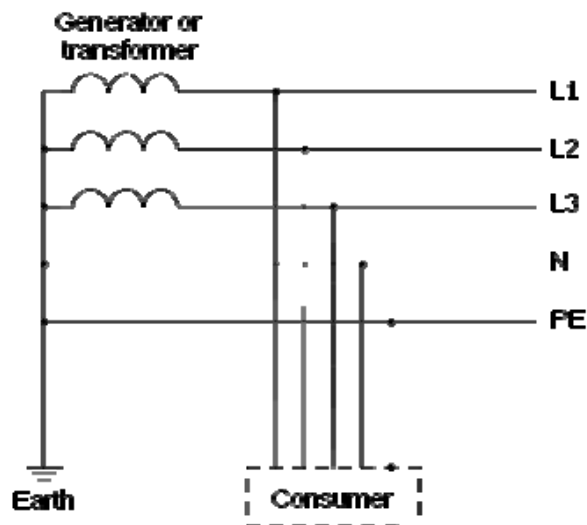

TN-C system

TN-C: PE and N are two separate conductors in an electrical installation similar to a three-phase 5wire system, but near the power side, PE and N are combined into a PEN conductor similar to a three-phase 4 wire system.

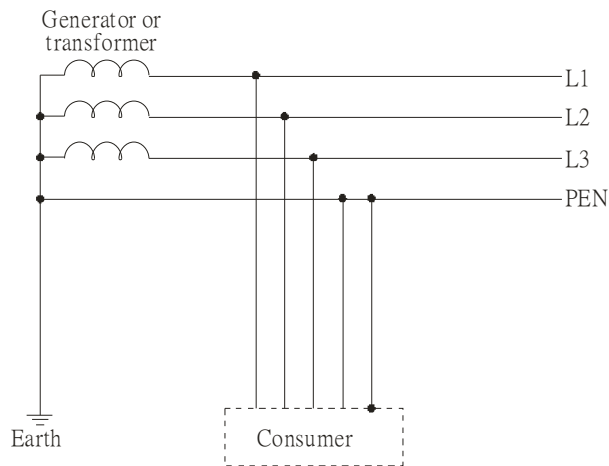

TN-C-S system

TN-C-S: A combined earth and neutral system (PEN conductor) is used in certain systems but eventually split up into two separate conductors PE and N. A typical application of combined PEN conductor is from the substation to the building but within the building PEN is separated into the PE and N conductors. Direct connection of PE and N conductors to many earthing points at different locations in the field will reduce the risk of broken neutrals. Therefore this application is also known as *protective multiple earthing (PME)* in the UK or as *multiple earthed neutral (MEN)* in Australia

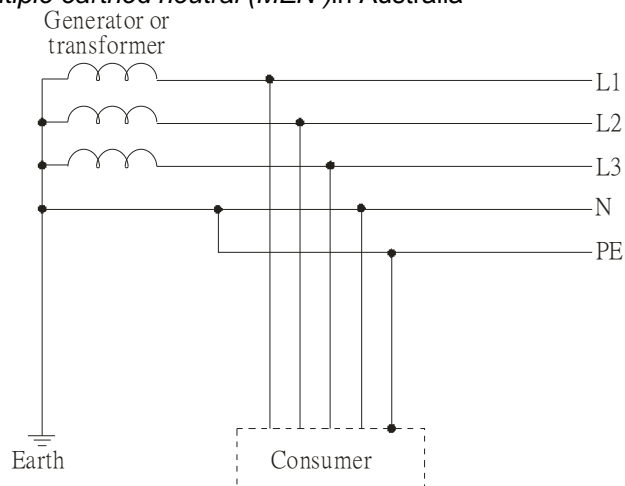

TT system

TT: The neutral point (N) of the low voltage transformer and the equipment frames (PE) are connected to a separate earthing point. The Neutral (N) of the transformer and electrical equipment are connected.

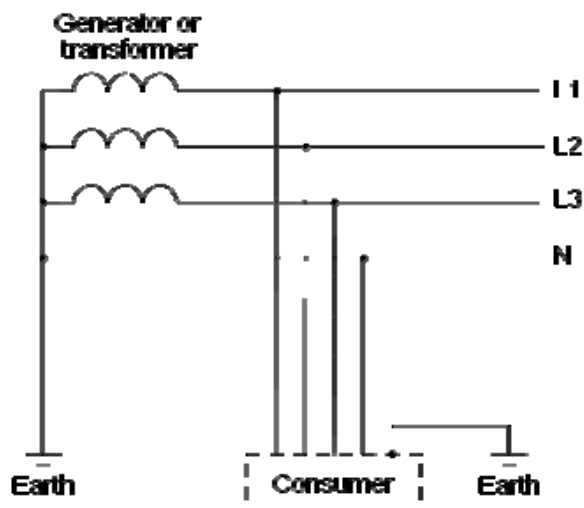

IT system

IT: The neutral point of the transformer and electrical equipment are not earthed, only the equipment frames PE are earthed.

In the IT network, the power distribution system Neutral is either not connected to earth or is earthed via a high impedance. In such a system, an insulated monitoring device is used for impedance monitoring. A built-in filter should be disconnected by the RFI-jumper and an external filter should not be installed when the AC motor drive or the AC servo motor drive is connected to an IT system.

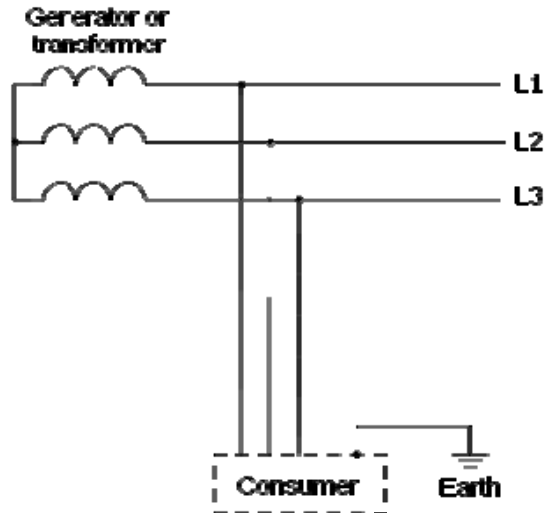

Criteria for earthing system and EMC

	TN-S	TN-C	TT	IT
Safety of Personnel	Good Continuity of the PE conductor must be ensured throughout the installation	Good Continuity of the PE conductor must be ensured throughout the installation	Good RCD is mandatory	Good Continuity of the PE conductor must be ensured throughout the installation
Safety of property	Poor High fault current (around 1kA)	Poor High fault current (around 1kA)	Good Medium fault current (< a few dozen amperes)	Good Low current at the first fault (< a few dozen mA) but high current at the second fault
Availability of energy	Good	Good	Good	Excellent
EMC behavior	Excellent Few equipotential Problems: - Need to handle the high leaking currents problem of the device - High fault current (transient disturbances)	Poor (prohibited) - Neutral and PE are the same - Circulation of disturbance currents in exposed conductive parts (high magnetic-field radiation) - High fault currents (transient disturbances)	Good - Over-voltage risk - Equipotential Problems: - Need to handle the high leaking currents problem of the device - RCD (Residual-current device)	Poor (should be avoided) - Over-voltage risk - Common-mode filters and surge arrestors must handle the phase to phase voltage. - RCDs subject to nuisance tripping when common-mode capacitors are present - Equivalent to TN system for second fault

Chapter 4 Solution to EMI: Shielding

4.1 What is Shielding?

Electrostatic shielding is used to isolate equipment so that it will not create electromagnetic field interference or be influenced by an external electromagnetic field. A conductive material is used for electrostatic shielding to achieve this isolation.

A *Faraday cage* can be made from a mesh of metal or a conductive material.

One characteristic of metal is that it is highly conductive and not electrostatic,, which offers shielding and prevents interference by external electrical fields. Metal with its high conductivity protects the internal devices from high voltages—no voltage will enter the cage even when the cage is experiencing a high current. In addition, electromagnetic fields can also pass through the Faraday cage without causing any disturbance.

Electromagnetic shielding is applied to some electrical devices and measurement equipment for the purpose of blocking interference. Examples of shielding include:

- earth high-voltage indoor equipment using a metal frame or a high-density metal mesh
- shielding a power transformer is achieved by wrapping a metal sheet between the primary and secondary windings or by adding an enamel wire to the winding wire which is then earthed.
- a shielding coating, which is made of metal mesh or conductive fibres to provide effective protection for the workers who work in a high-voltage environment.

In the picture below, the radio appears to be not fully covered by metal but if the conductivity of the metal is high, radio waves are completely blocked and the radio will not receive any signal.

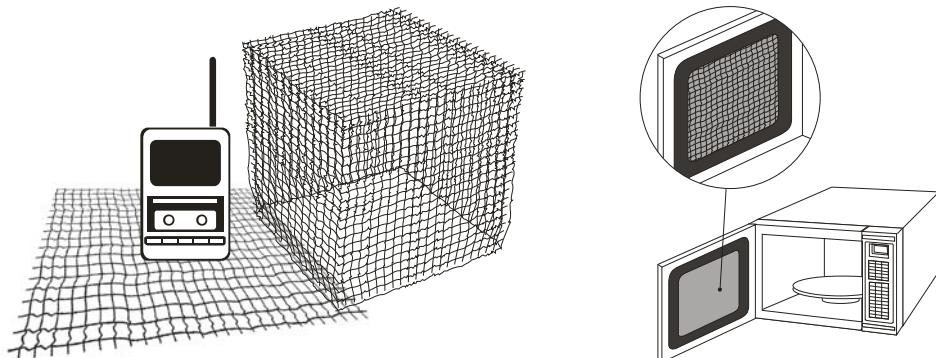

Mobile phone connections are also established through the transmission of radio waves. This is why the mobile phone reception is often cut off when we walk into an elevator. The metal walls of the elevator create the same shielding effect just as if we had entered a metal cage. Another example is a microwave oven. The microwave door may seem transparent in visible light, but the density of the metal mesh in the microwave door blocks the electromagnetic waves. A higher density of the metal mesh offers better shielding.

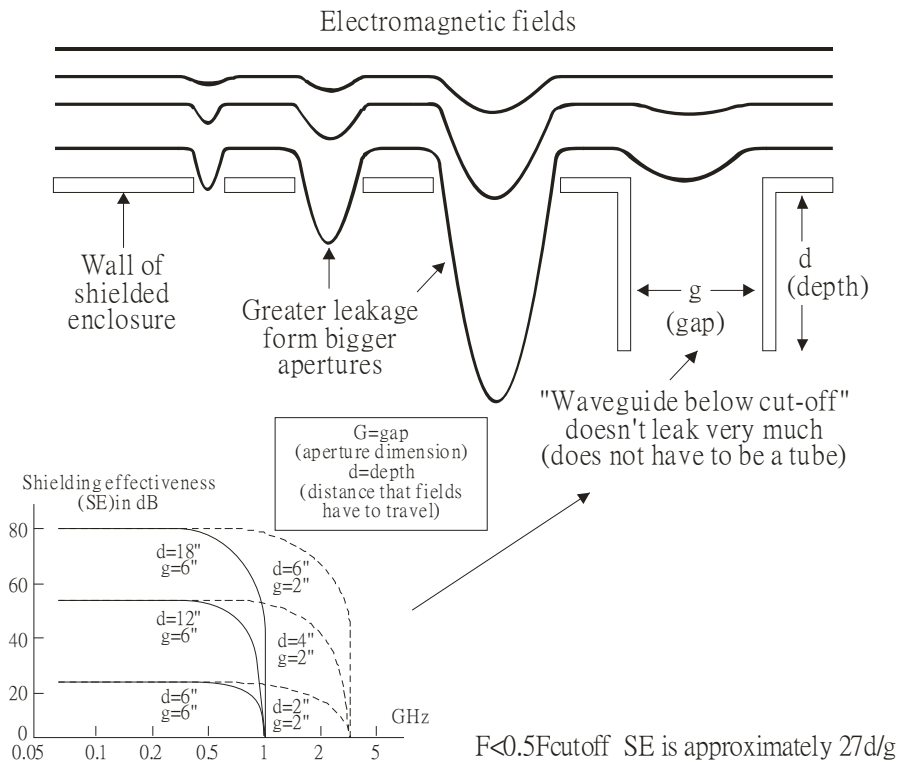

4.2 How to reduce EMI by Shielding?

Iron and other metals are high conductivity materials that provide effective shielding at extremely low frequencies. But conductivity will decrease as:

1. High frequency signals are applied to the conductor.
2. Equipment is located in a strong magnetic field
3. The shielding frame is forced into a specific form by machines.

It is difficult to select a suitable high-conductivity material for shielding without the help from a shielding material supplier or a related EMI institution.

Metallic Shielding Effectiveness

Shielding Effectiveness (SE) is used to assess the applicability of the shielding shell. The formula is:

$$SE_{dB} = A + R + B \quad \text{(Measures in dB)} \quad \text{where } A = \text{Absorption loss (dB)}$$

$$R = \text{Reflection loss (dB)}$$

$$B = \text{Correction factor (dB) (for multiple reflections in thin shields)}$$

The absorption loss refers to the amount of energy loss as the electromagnetic wave travels through the shield. The formula is:

$$AdB = 1.314(f\sigma\mu)^{1/2}t \quad \text{where } f = \text{frequency (MHz)}$$

$$\mu = \text{permeability relative to copper}$$

$$\sigma = \text{conductivity relative to copper}$$

$$t = \text{thickness of the shield in centimetres}$$

The reflection loss depends on the source of the electromagnetic wave and the distance from that source. For a rod or straight wire antenna, the wave impedance increases as it moves closer to the source and decreases as it moves away from the source until it reaches the plane wave impedance (377) and shows no change. If the wave source is a small wire loop, the magnetic field is dominant and the wave impedance decreases as it moves closer to the source and increases as it moves away from the source; but it levels out at 377 when the distance exceeds one-sixth of the wavelength.

Electrical Cabinet Design

In a high frequency electric field, shielding can be achieved by painting a thin layer of conductive metal on the enclosure or on the internal lining material. However, the coating must be thorough and all parts should be properly covered without any seams or gaps (just like a Faraday cage). That is only the ideal. Making a seamless shielding shell is practically impossible since the cage is composed of metal parts. In some conditions, it is necessary to drill holes in the shielding enclosure for installation of accessories (like optional cards and other devices).

1. If the metallic components are properly welded using sophisticated welding technology to form an electrical cabinet, deformation during usage is unlikely to occur. But if the electrical cabinet is assembled with screws, the protective insulating layer under the screw must be properly removed before assembly to achieve the greatest conductivity and best shielding.
2. Drilling holes for the installation of wires in the electrical cabinet lowers the shielding effectiveness and increases the chance of electric waves leaking through the openings and emitting interference. We recommend that the drilled holes are as narrow as possible. When the wiring holes are not used, properly cover the holes with metal plates or metal covers. The paint or the coating of the metal plate and metal cover should be thoroughly removed to ensure a metal-to-metal contact or a conductive gasket should be installed.
3. Install industrial conductive gaskets to completely seal the electrical cabinet and the cabinet door without gaps. If conductive gaskets are too costly, please screw the cabinet door to the electrical cabinet with a short distance between the screws.
4. Reserve a grounding terminal on the electrical cabinet door. This grounding terminal shall not be painted. If the paint already exists, please remove the paint before grounding.

Electrical wires and cables

Shielded Twisted Pair (STP) is a type of cable where two insulated copper wires are twisted together with a metal mesh surrounding the twisted pair that forms the electromagnetic shielding and can also be used for grounding.

The individual electrical wires and complete cable are surrounded by (synthetic) rubber, that provides insulation and also protects against damage.

There are two types of electrical cables: high voltage and low voltage. The high voltage cable differs from the low voltage cable in that it has an additional insulation layer called the dielectric insulator within the plastic sleeve. The dielectric insulator is the most important component in insulation. The low voltage cable is usually only filled with a soft polymer material for keeping the internal copper wire in place.

The shield has two functions.

1. To shield the electrical wire and cable.
 - A. Electric currents increase as power flows through the power cable and generate an electrical field. Such interference can be suppressed inside the cable by shielding the power cables or the electrical wires.
 - B. To form a protective earthing. When the cable core is damaged, the leakage current will flow via the shield to ground
2. To protect the cable. A power cable used for the computer control purpose generates only relatively low amount of current inside the cable. Such power cable will not become the source of interferences but has great possibility to be interfered by the surrounding electrical devices.

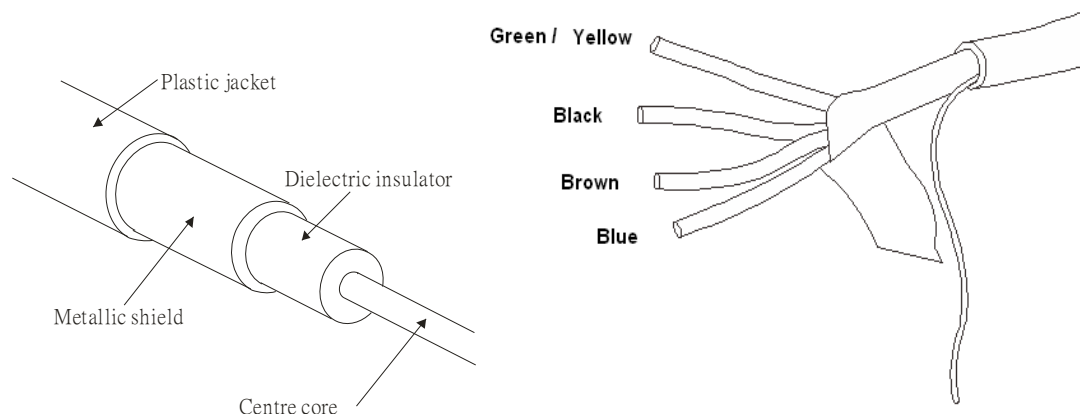

Chapter 5 Solution to EMI: Filter

5.1 Filter

Electromagnetic interference is transmitted in two ways, by radiation and by conduction. The most effective and economical method of reducing radiated interference is to use shielding and of reducing conducted interference is to use an electromagnetic filter.

Noise interference can be divided into two categories: high frequency (150kHz~300MHz) and low frequency (100Hz~3000Hz). High-frequency noise fades more over distance and has a shorter wave-length, while low-frequency noise fades less over distance and has a longer wave-length.. Both types of interference are transmitted through power cables and power leads, affecting the power supply side.

High-frequency interference at the power side can be eliminated or attenuated by mounting a filter. The filter consists of coils and capacitors. Some drives do not have a built-in filter, in which case the installation of an external option filter is required. The drawing below shows a standard filter diagram:

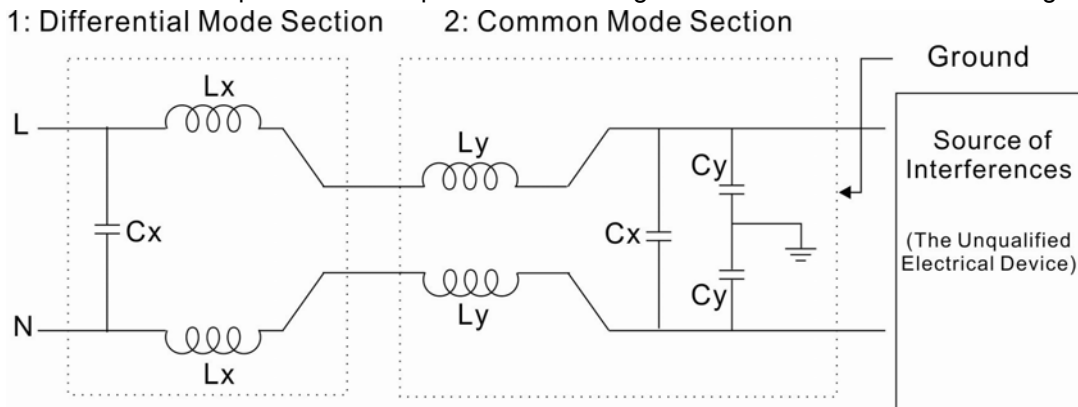

A filter is composed of a Differential Mode section (to eliminate noise below 150kHz) and a Common Mode section (to eliminate noise above 150kHz). For high-frequency noise, the inductor acts as a high impedance to form an open circuit and the capacitor acts as a low impedance to form a short circuit. Proper design and dimensioning of inductors and capacitors give a resonant circuit to absorb harmonic currents. Capacitor C_y is earthed to lead the harmonic currents to the ground.

External Filter

The filter and the AC drive should be installed in the control cabinet or on the mounting plate that is earthed to ground. The motor cable must be shielded and as short as possible. Please use the filters recommended by Delta to ensure compliance with EMC standards.

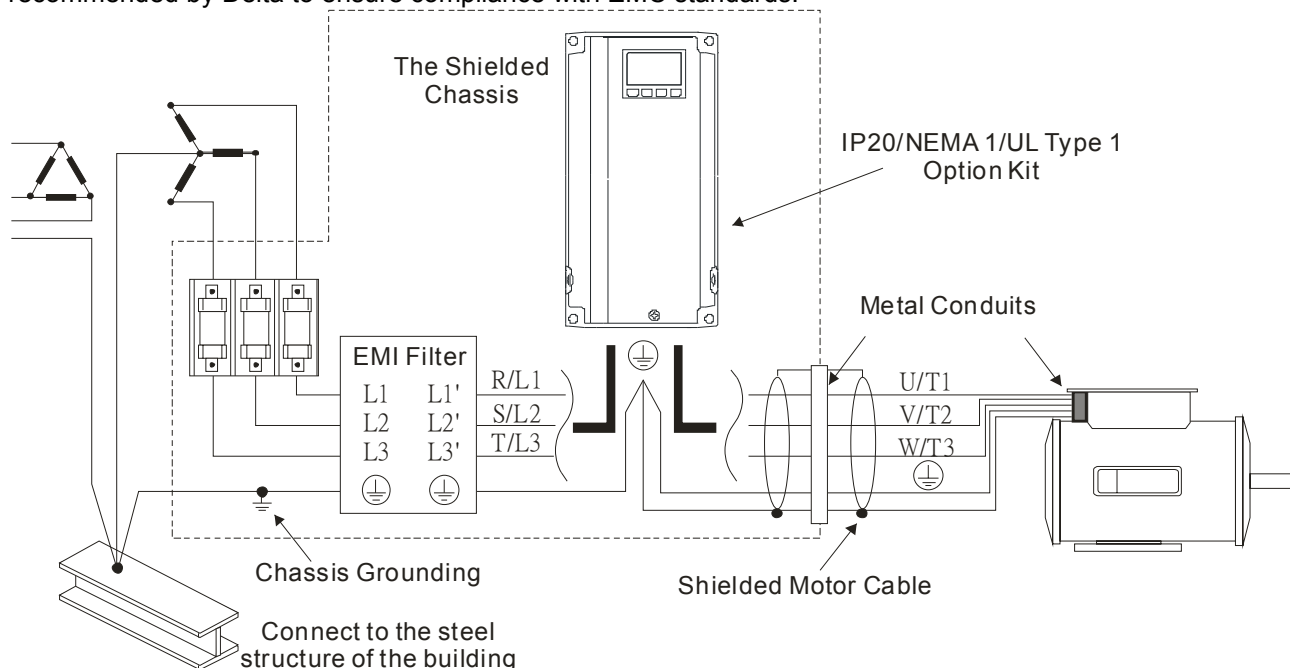

AC Motor Drives with Built-in Filter

1. Since interferences are suppressed by installing an earthed capacitor in the filter, the amount of current to ground (leakage current) could result in electric shocks to personnel or the power system. Please be aware of this problem.
2. Since the leakage current to ground can be high, it is crucial to implement protective earthing to prevent electrical shocks.

Filter Installation (With and Without)

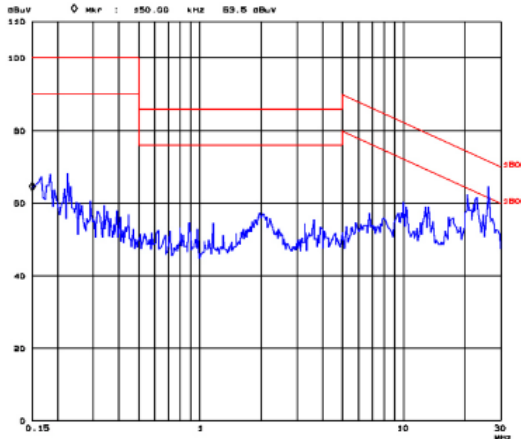

<15m@60Hz with EMI Filter>

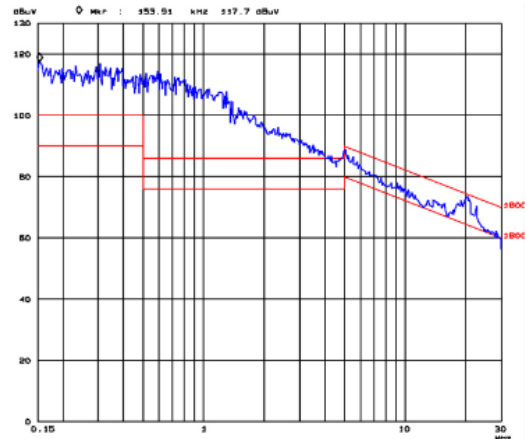

<15m@60Hz without EMI Filter>

Zero Phase Reactor (Choke)

Interferences can also be suppressed by installing a zero phase reactor at the power supply side and/or the AC Motor Drive's output, depending on where the interference is. Since currents are large at the power input and the AC Motor Drive's output, please carefully select the magnetic core with suitable current handling capability. An ideal magnetic material for large currents is compound magnetic powder. It has a higher current handling capability and higher impedance compared to pure metallic magnetic cores. It is therefore suitable to implement in a high frequency environment. The impedance can also be enhanced by increasing the turn ratio.

Zero Phase Reactor Installation

There are two installation methods, depending on the size of the zero phase reactor and the motor cable length.

1. Wind the motor cable through the middle of a zero-phase reactor 4 times. Place the reactor and the AC Motor Drive as close to each other as possible.

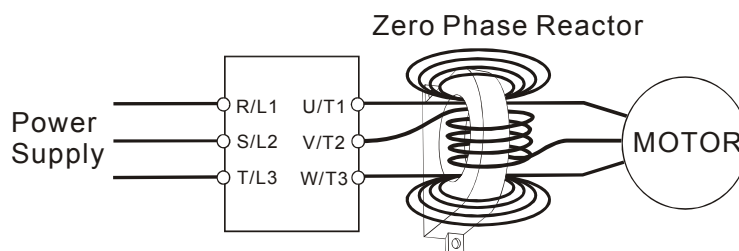

2. Place all wires through the middle of four zero-phase reactors without winding.

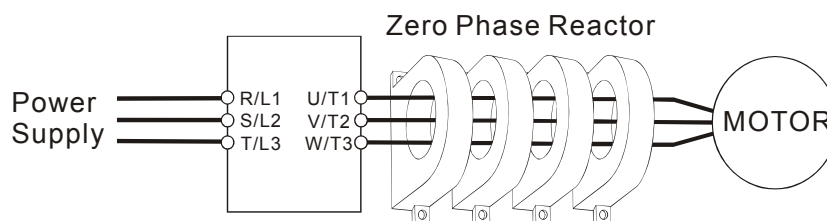

Analog Input Signals

If the analog input signals are affected by noise from the AC motor drive, please connect a capacitor and a ferrite core as indicated in the following diagram.

Wind the wires around the core in same direction for 3 times or more.

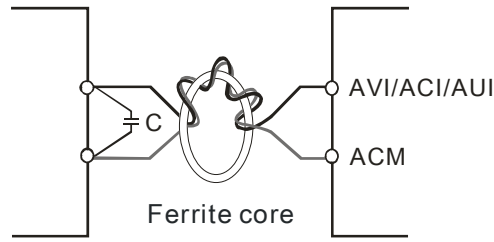

5.2 Harmonic Interference

The AC motor drive's input current is non-linear, the input rectifier generates harmonics. Harmonics must be limited to within a certain range to avoid impact the mains power and to avoid current distortion to ensure surrounding devices are not influenced. An AC Motor Drive with built-in DC reactor suppresses harmonic currents (Total Harmonic Current Distortion THID) effectively and therefore reduces the harmonic voltage peaks (Total Harmonic Voltage Distortion).

Harmonic Current at the Power Supply Side

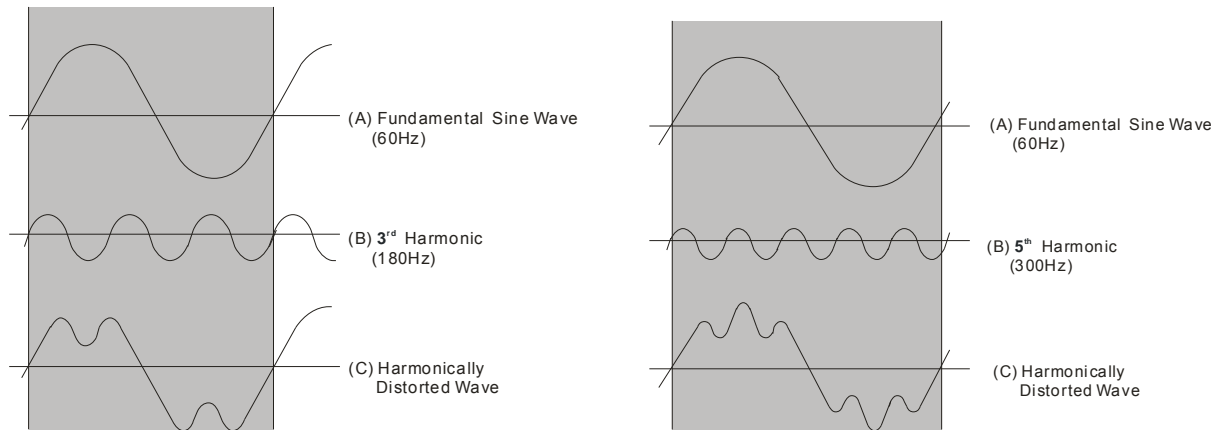

Suppression of Harmonic Currents

When a large portion of lower order harmonic currents (5th, 7th, 11th etc) occur at the power input, surrounding devices will be disturbed and the power factor will be low as a result of reactive power. Installing a reactor at the AC Motor Drive's input effectively suppresses lower order harmonic currents.

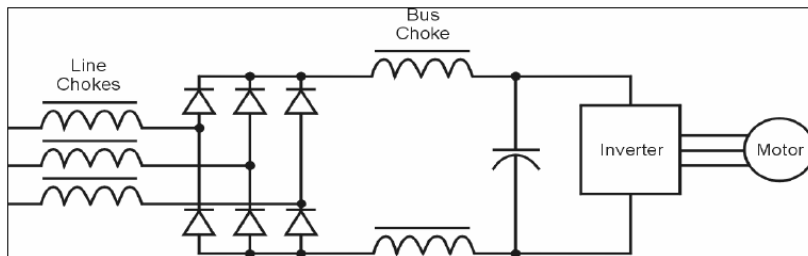

AC Reactor

Installed in series with the power supply and is effective in reducing low order current harmonics.

Features of an AC reactor include:

1. Reduces the harmonic currents to the AC Motor Drive and increases the impedance of the power supply.
2. Absorbs interferences generated by surrounding devices (such as surge voltages, currents, and mains surge voltages) and reduce their effect on the AC Motor Drive.
3. Increases the power factor.

DC Reactor

A DC-Reactor is installed between the rectifier and the DC-bus capacitor to suppress harmonic currents and to achieve a higher power factor.

Current Wave Diagrams

